

INNOTEK® *Quicker Training. Better Dogs.* **ULTRASMART**



INNOTEK® UltraSmart™ In-ground Pet Fencing Systems

IUC-4100, IUC-4200, IUC-5100, IUC-5200



Invisible Technologies, Inc.
1-800-826-5527
www.innotek.net

1204

2100277-1

About Your INNOTEK® UltraSmart™ In-Ground Pet Fencing System

Discover what a difference an in-ground fencing system can make. You'll discover the ease and convenience of keeping your dog safe in your yard without the structure and expense of traditional fencing.



Collar Charging Station plugs into any 110v AC wall outlet. The collar fits in the cradle and charges the collar in just 2-3 hours. It's an attractive unit designed for use in your home.

Boundary Wire is burial grade and rugged for virtually any ground conditions. You'll lay the wire about 3-inches deep. Twisting the boundary wire creates areas in your yard that the dog can safely pass over. Pre-twisted FasTrak™ is included in IUC-4200, IUC-5100, IUC-5200 and many other Innotek fencing systems.

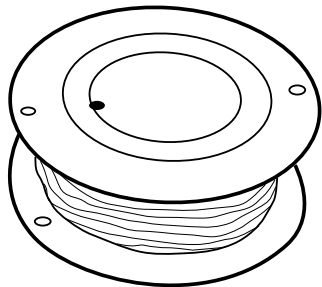

The **UltraSmart Collar** has been designed by professionals to offer optimal training stimulation in a sleek, low profile design. The collar is packed with features including PerfectFit™, an indication that the collar is fitted properly to your dog.

You MUST charge collar for 3 hours prior to first use.

Lightning Protection is an important part of your system. This module is connected between the loop wire and the transmitter. Without lightning protection, a lightning strike within 1-2 miles of your installation can surge through loop wire or AC power and may damage your transmitter. Lightning protection is included in IUC-4200, IUC-5100, and IUC-5200, and many other INNOTEK® fencing systems. Lightning protection module is also available as a separate purchase; call us at 1-800-826-5527.

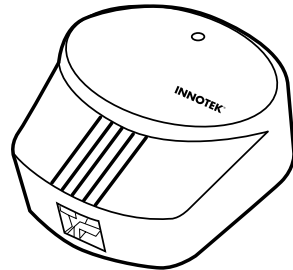

The **Wall-mount transmitter** controls the fencing field. Mount it indoors, with field wires passing through the wall and buried in the ground. You set controls to adjust the size of the fencing field, strength of correction, and more.

ABOUT ZONES
Your dog's collar will also work with the Zones™ system, indoor avoidance to keep your dogs away from things in your home. See page 9.

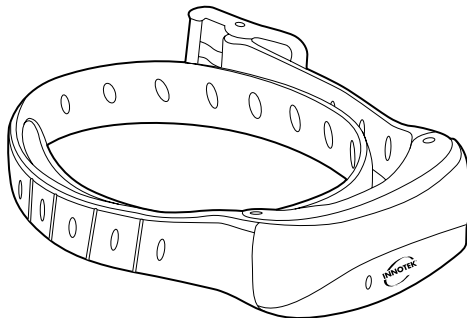

Important: Never leave the collar on the dog for more than 12 consecutive hours. See "Important Advice", page 3.

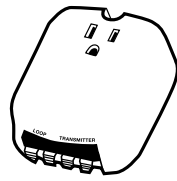

INNOTEK® UltraSmart In-ground Pet Fencing Systems

Quick Start Guide

IUC-4100, IUC-4200, IUC-5100, IUC-5200

Follow Page Numbers For Detailed Instructions

Step 1 Design Your Fence

Have the local utility companies mark your underground lines; in most communities this is a free service. On a sheet of paper, sketch your house and yard. Draw a line around your property that represents the containment area for your dog, avoiding underground utility lines. Where it is not possible to avoid utility lines, run your wire perpendicular to the underground lines.

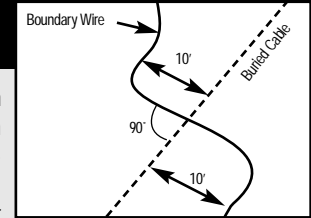

Page 5

Step 2 Install the Wall-mount transmitter

Locate the transmitter indoors on an exterior wall near an AC power outlet; inside a garage or basement is ideal. The containment twisted wire will need to run from the transmitter and pass through a window or small drilled hole to the outdoors.

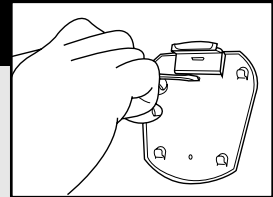

Page 6

Step 3 Lay Out the Fence Wire

Run the containment wire around the property as outlined in your plan. Use gradual rounded corners with wide radiuses. Avoid sharp (90°) angles.

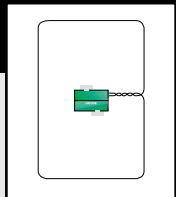

Page 6

Step 4 Final Connections

Splice each end of your pet fencing loop wires to the twisted wire. You must use the supplied waterproof splices. Connect the lead ends of the twisted wire to the wall mount transmitter. Plug in the AC Adapter and connect it to the transmitter. Turn the transmitter ON. The transmitter's green light should illuminate, indicating a successful continuous loop.

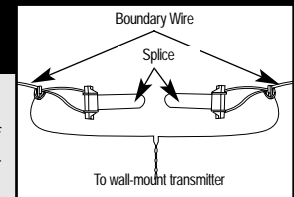

Page 7

Step 5 Charge Collar

Choose a location close to a door that you and your dog use regularly and plug in the wall charger. Position the collar in the charging cradle. The collar fits in the cradle with the collar light to your left and with the contacts that touch your dog's skin facing down. The collar's light glows red while charging, green when charging is complete.

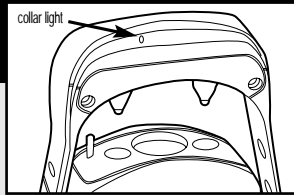

Page 8

Step 6 Test Your Fence

Set the FIELD WIDTH ADJUSTMENT knob inside the transmitter to the 9 o'clock position. Hold the supplied test light across the skin contacts and walk the dog's collar up to the fence wire. Listen for the warning tone and look for the test light to illuminate. You should receive a signal 8 to 12 feet from the wire. To increase field width, rotate the adjustment knob clockwise. Test the collar in different places around the fenced area to verify the range is consistent.

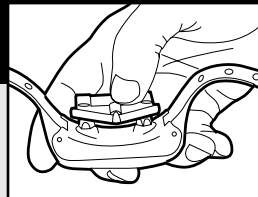
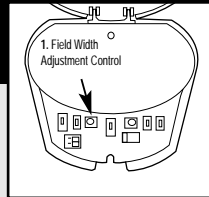

Page 8

Step 7 Bury Fence Wire

Dig a trench about 3-inches deep, using a straight-edged spade or gas-powered edger. Digging the trench at an angle helps keep the wire in the ground where you place it. Place training flags at edge of selected boundary field where the warning tone is first heard, NOT at the wire.

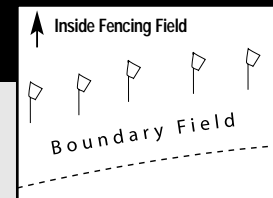

Page 9

Step 8 Train Your Dog

Watch the training DVD and follow the training steps outlined in the separate Training and Troubleshooting Guide. Your dog may show good initial response to the training; be sure to follow the training procedure for several weeks. The convenience that your new fence offers plus the added safety for your dog and family are well worth the time invested.

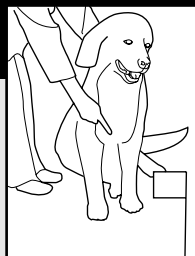

IMPORTANT ADVICE

1. Read the complete manual and follow all directions. If you have any questions, please call 1-800-826-5527.
2. This device is intended for use only on dogs. Never attempt to use it for any purpose not described in this manual.
3. Keep out of the reach of children.
4. Never perform set-up procedures while the collar is on your dog.

5. Any collar worn for extended periods can cause a condition similar to bedsores, known as Pressure Necrosis. To reduce the possibility, you must do the following:
 - Never leave the collar on the dog for more than 12 consecutive hours per day.
 - Check the fit to prevent excessive pressure; you should be able to insert one finger between the collar strap and your dog's skin.
 - Examine the dog's neck daily for any signs of a rash or a sore.
 - Wash the dog's neck area and the probes of the collar weekly with a damp cloth.
 - If the condition persists beyond 24 hours, see your veterinarian.

6. Metal tags and collars should be removed as they may interfere with proper operation.
7. Do not attempt to dismantle or repair any components of this system; doing so will void the warranty in full. The computerized circuitry should be serviced only by an authorized expert.
8. Realize that because dogs have unique temperament, there is no way of knowing how your dog will react to the introduction of a pet fencing system. For the safety of your dog, a long lead should be used during initial training so you have control of the situation.
9. If you have reason to believe that your dog may pose a danger to others, harm itself, or react adversely to the collar, do not rely solely on this product to contain your dog. If your dog shows signs of growling, snarling or biting while using the collar, stop immediately. Aggression in dogs has many causes. We recommend that you consult a knowledgeable professional dog trainer or animal behaviorist with experience with aggressive dogs if your dog has shown any of these characteristics.

10. Occasionally, a dog cannot be trained to respond to a pet fencing collar. Sometimes even a properly trained dog may disobey a command. Therefore, Invisible Technologies, its distributors, and dealers cannot guarantee that the system will in all cases keep the customer's animal from disobeying commands.

WE CARE. CALL US FIRST.
1-800-826-5527

LIMITED LIFETIME WARRANTY

Invisible Technologies warrants to the original retail purchaser, that INNOTEK® brand products will be free from defects in material and workmanship, under normal use, for a period of one year from the date of the original retail purchase. This Limited Warranty excludes: accidental damage due to dog chews; lightning damage where an INNOTEK® lightning protection component is not in use (in-ground pet fencing systems); or neglect, alteration and misuse.

Invisible Technologies offers several product exchange options during the warranty period. If service is required, call 1-800-826-5527 to discuss the service plan that best serves your needs. Costs are dependent on the processing time and the desired shipping options. Please do not return this product to your retailer.

After one year from date of original retail purchase, we will repair, replace or upgrade your product at a fixed rate based on the component.

Invisible Technologies, Inc., shall not be liable or responsible for any incidental or consequential damages resulting from the use of the product or caused by any defect, failure or malfunction of the product, whether a claim is based upon warranty, contract, negligence or otherwise.

FREE Professional Training Support
Additional behavior or training issues?
Looking for the best way to get a well-behaved dog?
Call our FREE Professional Training Support hotline at
1-800-364-3362

INNOTEK® UltraSmart™ In-ground Pet Fencing System

Depending on the system purchased, you should have received the following components:

	IUC-4100	IUC-4200	IUC-5100	IUC-5200
Wall mount transmitter	●	●	●	●
Installation Wire Pre-twisted Fastrak™ Wire		●	●	●
UltraSmart in-ground fencing collar	●	●		●
UltraSmart Contain N Train® collar			●	
Contain N Train handheld remote			●	
ZONES™ transmitter				●
Lightning Protection		●	●	●
Training DVD	●	●	●	●

The Wall-Mount Transmitter

The transmitter is the system's control center. Lift the hinged front cover to reveal the switches that can customize your system.

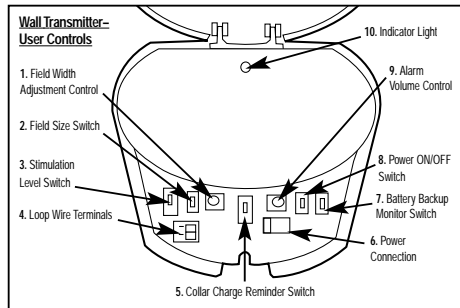

Wall Transmitter User Controls

1. Field Width Adjustment Control
2. Field Size Switch
3. Stimulation Level Switch
4. Loop Wire Terminals
5. Collar Charge Reminder Switch
6. Power Connection
7. Battery Backup Monitor Switch
8. Power Switch ON/OFF
9. Alarm Volume Control
10. Indicator Light

1. **Field Width Adjustment** – Controls the distance from the wire your dog can venture before hearing the warning tone and receiving correction.

2. **Field Size Switch** – Set switch to small (SM) for installations of 1,000 feet of wire or less.
3. **Stimulation Level Switch** – Select from levels Low, Medium, or High, the correction level your dog will feel after the 2-second warning tone (LOW and MED selections only). The tone and correction occur at the same time when level is set on HIGH.
4. **Loop Wire Terminals** – Spring-loaded connections for the pet fencing wire.
5. **Collar Charge Reminder Tone Switch** – Not required with this system. Set to OFF.
6. **Power Connection** – Power for the pet fencing system. Connect the 24-volt DC adapter plug here, and then plug the adapter into any 110v AC outlet.
7. **"24/7" Battery Backup Monitor Switch** – If power to the system is interrupted, the battery back-up will keep the system working up to 40 hours. Install 8 AA alkaline batteries (not included). The monitor will sound when batteries need to be replaced. For the safety of your dog, the battery backup monitor should be switched to ON and kept in good working order at all times.
8. **Power** – ON/OFF Switch
9. **Alarm Volume** – Controls the volume of wall transmitter alarms. Will not silence the alarm.
10. **Indicator Light and Alarm** – The light on the front of the transmitter will indicate the following conditions.

TRANSMITTER STATUS INDICATIONS		
STATUS light	ALARM TONE	CONDITION
Solid Green	No	Power On/System OK
Flashing Red	Twice per second	Boundary Wire Broken/Disconnected
Flashing Yellow	Once per second alarm can be turned off with battery backup monitor alarm switch	Backup Batteries Low
None	Once per 5 seconds	AC Power Disconnected: Unit Operating on battery
None	No	Transmitter is OFF or Power is disconnected

External Lightning Protector

Several systems include external lightning protection, which helps protect the transmitter from electrical power surges and lightning strikes near your boundary wire. A nearby lightning strike can cause failures due to high voltage damaging your transmitter. Severe lightning strikes may damage the Lightning Protection, which is designed to be a sacrificial link in the system. This enhanced lightning protection (LP-4100) is available for other INNOTEK® pet fencing systems by calling 1-800-826-5527.

The Collar

The lightweight comfortable collar is integrated into a fashionable collar strap your dog wears. The collar administers the warning tone and correction should your dog attempt to leave the yard. The collar is rechargeable; place the collar on the charging cradle located on top of your charger station. The collar's light glows red while charging; it glows green once charging is complete.

IUC-5100 Contain 'N' Train users – your collar features 2 lights. The one on the left reflects status of the system's in-ground fencing, the light on the right reflects commands from the handheld remote.

PerfectFit™ test

When you remove the collar from the charger, the system will run through ReadyTest™ for about 8 seconds, and then enter PerfectFit™ mode (blinking amber light). You have approximately 90 seconds to fit the collar to your dog as described below. As the unit makes successful skin contact, it will emit a quiet but audible click. After 5 consecutive clicks, you have positive confirmation of the correct fit.

Should you not fit the collar within 90 seconds of removal from the charger, it will operate without the PerfectFit™ Test.

Fitting the Collar on your Dog

The collar strap should fit snugly towards the top of your dog's neck with the collar electronics on the bottom of the neck.

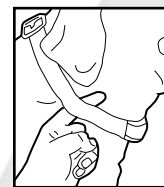

Check that the INNOTEK® logo is right-side up. You should be able to get one finger between the collar strap and your dog's neck. The contacts must make contact with the dog's skin for proper operation. A little hair thinning may be required.

Occasionally, check the tightness of the skin contacts to ensure they will not be lost from the collar. Lost components are not covered under your warranty.

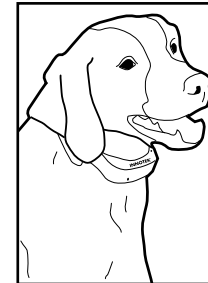

Trim excess strap along the diagonal score marks. You'll want to leave several inches of excess strap. Note if your dog is young and you expect him/her to grow, you'll want to leave extra strap to adjust the collar fastening. Replacement straps are available. Call us at 1-800-826-5527.

Over-Stimulation Prevention – In the unlikely event that your dog "freezes" in the pet fencing field, this feature limits stimulation duration to 10 seconds. The system locks out further stimulation for 10 seconds before resuming stimulation for another 10 seconds. This pattern will repeat for a maximum of three cycles, a duration of 60 seconds.

Collar Status Indicators

Status Light	Tone	Condition
Pulsating Green	Duration of Tone button press	Tone only – no stimulation
Pulsating Red	Duration of the Stimulation	Stimulation being delivered (up to 10 seconds)
Continuous Green	No tone	Over-stimulation warning collar locked for 10 sec.
Blinking Green	No tone	Collar battery 60% strength or better
Blinking Amber	No tone	Collar battery 60-20% strength
Blinking Red	No tone	Collar battery less than 20% strength; charge immediately
After Removing From Charger		
Continuous Green/Amber/Red	No Tone	Battery Strength (see above)
Continuous Red	20 sec	Self-test failure; unit is not operational
Blinking Amber	No Tone	Unit is in ReadyFit™ mode for 90 sec after turning on
Blinking Green	Click; 5 consecutive clicks for confirmed fit	ReadyFit™ mode indicates collar is making true contact with dog's skin
While on Charger		
Solid Red	No Tone	Charge in progress
Solid Green	No Tone	Charge complete
No Light		Charge failure

Run-Through Prevention – This INNOTEK® system includes a unique "run-through" prevention so that your dog cannot escape the pet fencing field without activating a strong stimulation. The collar automatically increases the stimulation when your dog continues more than 1/3 of the way through the pet fencing field, regardless of the transmitter stimulation level setting. For example, if the signal is detected 12 feet from the wire and your dog enters the pet fencing field, this feature is activated when he is approximately 8 feet from the wire. At this point, your dog automatically receives the highest level of stimulation.

Step 1 Design Your Fence

The pet fencing wire must form a complete loop from the transmitter.

Although the pet fencing wire is only buried 1 to 3-inches, make sure you contact your utility companies to mark underground cable and wire locations before you dig. In most communities, marking the utility lines is a free service.

DO NOT run a wire within 10 feet or parallel to cable TV, phone, or electrical lines. The signal can couple together, causing inadvertent collar activation in the house and safe parts of the yard. You can minimize interference by crossing perpendicular to these lines. See Quick Step 1 illustration.

For your dog's safety, we recommend keeping the pet fencing wire at least 10-feet from the street. Keep in mind that you will want to place the wire where there is room for an 8-12 foot pet fencing field from the buried wire.

Step 2 Install the Wall-mount transmitter

1. Select a Location – Select an indoor, dry location to hang the wall-mount transmitter. You will need a standard 110v AC grounded outlet within 5 feet to power the transmitter. Most people find an inside exterior wall of a garage or basement works well. You will need easy access to run the pet fencing wire outside.

2. Install the Mounting Plate – The mounting plate is attached to the back of the transmitter. Remove by lightly depressing the top tab and sliding the transmitter housing up the plate. Use the mounting plate as your template and mark holes with pencil. Fasten plate with supplied screws and wall anchors if necessary.

3. Install Battery Backup Batteries – (Optional, but recommended) In the event your power goes out, your system can run for up to 40 hours on 8 AA batteries (not included). Install batteries and set BATTERY BACKUP MONITOR switch to the ON position. If you choose not to use the battery backup system, set the BATTERY BACKUP MONITOR switch to OFF.

4. Provide for wire access to outside – You will need to get the wire from the transmitter to outside where the pet fencing loop will run. This can be done through a window or you can drill a 1/4-inch hole at the base of the wall to pass the wire through. After final installation and testing is complete, caulk the hole to prevent damage from moisture or insects.

With the transmitter installed and the hole drilled for the wire, you can position the boundary wire that will form your fence. DO NOT bury the wire until you are sure that the system is functioning properly.

Step 3 Lay Out the Fence Wire

1. Amount of wire

Your system includes 500 feet of boundary wire. The IUC-4200, IUC-5100 and IUC-5200 include an additional 100 feet of pre-twisted wire. For larger areas, boundary kits with wire and splices, as well as convenient pre-twisted wire are available from your retailer or call 1-800-826-5527. The chart below offers some examples of wire coverage area.

Acres	Linear FT Needed
1	850
2	1200
3	1500
4	1700
5	1900

Front and Back Yard Loop. The most common installation. The wire is placed just inside the property line to form a square or rectangle.

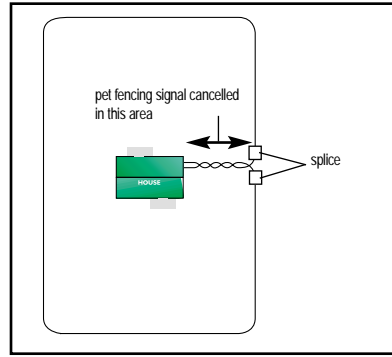

Front and Back Yard Loop

Hourglass Loop. Allows your dog to be contained in either the front or back yard but not around the side of the house. When the wire runs parallel to itself as it goes toward the side of the house be sure the wires don't come within 6-feet of one another to avoid canceling the signal.

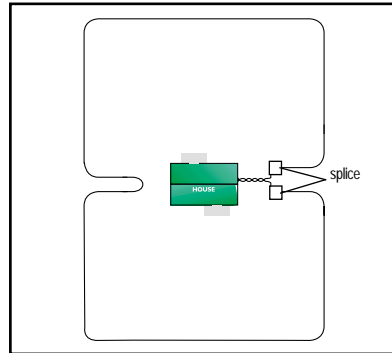

Hourglass Loop

Double Loop. Confines your dog to the backyard only. The wire needs to run around the backyard, using the house as a natural barrier and doubling back to the transmitter to finish the complete loop. When doubling back, make sure that there is at least 6-feet between the lines to avoid canceling the signal.

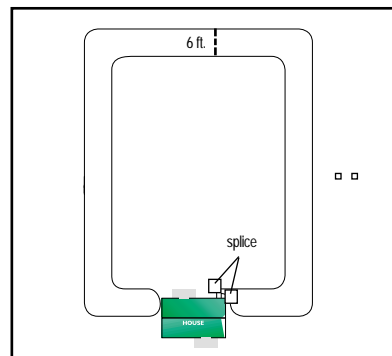

Double Loop

Customized Loops. You can create off limit areas, such as pools and gardens by encircling the area with wire. Run twisted wire from the fence loop to the encircled area, and splice the ends together.

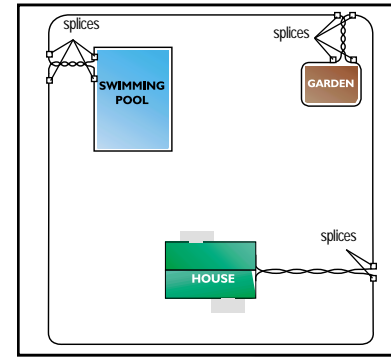

Customized Loops

2. Rounding Corners

Use gradual turns at the corners with a minimum of 2.5-foot radius. This will produce a more consistent pet fencing field.

3. Placing the wire

The wire must make a continuous loop from the transmitter and back again. The signal passes from one transmitter terminal around the loop and back to the transmitter again. Keep in the mind that you will want an 8 to 12-foot pet fencing signal field from your wire, so don't run the wire too close to the house and make passageways too narrow for your dog to pass.

4. Twisted Wire

Twisted wire cancels the radio signal coming from your transmitter. This enables your dog to cross over the wire in the safe part of the yard. Where there is single wire, the fence is active and your dog will be unable to pass. Your kit may have come with FasTrak pre-twisted wire or you can purchase it as a separate kit by calling 1-800-826-5527.

You can twist your own wire by cutting two equal lengths of wire supplied and twisting them together. Anchor one end of the wires to something secure and insert the other end in a power drill. Pull wire taut. The drill enables you to twist the wire quickly. You will need at least 12 twists per foot to effectively cancel the radio signal.

IMPORTANT TIPS

DO NOT run wire within 10 feet or parallel to cable TV, phone or electrical lines. The signals can couple together, causing inadvertent collar activation in the house and safe parts of the yard.

The wire must form one continuous loop from the transmitter.

Work carefully. A nick in the wire can diminish signal strength and create a weak area where your dog can escape.

Use twisted wire to run between the transmitter and the interior loops, such as around pools and gardens. This will allow your dog to safely pass around these areas. (Reference Custom Loop illustration.)

Step 4 Final Connections

1. Splicing to the boundary wire – Pull the twisted wire to the perimeter location of the two ends of your boundary wire

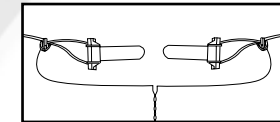

loop. Splice the ends of the twisted wire to the ends of the boundary wire with the supplied waterproof splices as

shown. Use only waterproof splices supplied with this system. Additional splices are available by calling 1-800-826-5527, or at www.innotek.net. Use of wire nuts alone, electrical tape or solder will not provide a waterproof and secure connection for your system to function properly long-term.

To use the gel-filled capsule splice, strip 5/8-inch of insulation from the wire ends. Insert ends of wire into nut and twist to secure. Insert the wire nut as deeply as possible into the waterproof gel and snap the lid shut. Tie a knot in the wires as shown in Quick Step #4 to avoid having the wires pull free during installation.

Only two wires can go into one splice.

2. Bring outside wire to transmitter – From the outside, push the twisted pair of wires through the hole in the wall. Strip about 1/2-inch of insulation from the two ends. Insert ends into loop wire spring-loaded terminals marked on the transmitter. (If using Lightning Protection, see alternate wiring described on page 8).

3. Plug transmitter in – Use supplied power adapter and plug adapter into the jack provided on the transmitter. Plug the power adapter into a 110v wall outlet. Set transmitter power switch to the ON position. The green light should illuminate on your transmitter indicating a properly installed boundary loop. If the light does not come on, refer to the Training and Troubleshooting Guide.

Place the power cord wire under the wire retention tab of the housing.

Final Connection Layout With Lightning Protection

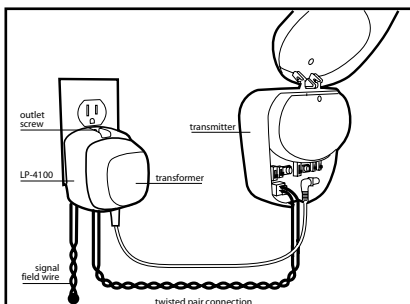

1. If using lightning protection module, connect the twisted wire ends from the pet fencing field to the spring-loaded terminals marked "loop" on the lightning protection.
2. Use a short piece of twisted wire to connect from the terminals marked "transmitter" on the Lightning Module to the "Loop" terminals on the wall-mount transmitter.
3. Plug Lightning Protection Module into the grounded 110v outlet.
4. "Piggyback" the transmitter power adapter onto the AC outlet on the Lightning Protection Module. See illustration.

Step 5 Charge Collar

The collar charging station has been designed to plug into a standard 110v wall outlet and act as a charging stand for your collar. It's an attractive unit designed for use in your home.



Choose a location close to a door that you and your dog use regularly and plug in the wall charger. Position the collar in the charging cradle. The collar fits in the cradle with the skin contacts facing down through holes in the case. A built-in safety circuit prevents the unit from overcharging. The collar's light glows red when the collar is properly seated and charging; it will turn green when charging is complete.

The collar will achieve a full charge in 2-3 hours. Each charge can last up to two months.

Battery Caution: Do not charge your collar every night. Frequent charging can have a negative effect on your collar's battery. We recommend the collar be used until battery status light blinks red.

ReadyTest™ feature

When you remove the collar from the charging station, the unit will automatically go into self-test mode for about 8 seconds. The collar's internal diagnostics will check that the battery charge is full and that all circuits are working correctly. Do not touch the skin contacts during this test. Ready Test gives you added confidence that your pet fencing collar is working and ready to go.

If Continuous Red: If the ReadyTest™ self-test fails, the unit will tone and the LED will glow solid red for 20 seconds. Replace in the charger for 5 seconds, then remove. Do not touch the metal contacts. If the unit continues to fail, call us at 1-800-826-5527.

PerfectFit™ Test for Skin Contact

As part of the ReadyTest™, the collar will go into PerfectFit™ mode. The collar will emit a click tone as the contacts touch your dog's skin. A proper fit will be acknowledged with 5 consecutive click tones.

To skip the PerfectFit™ test, just wait 90 seconds after removal from charger. The collar will function normally, bypassing the PerfectFit™ test.

Step 6 Test Your Fence

You should have your boundary wire laid out on top of your lawn and properly connected. The collar should have charged for 2-3 hours. DO NOT test the system on your dog.

1. Field size switch – Set to small (SM) for installations using less than 1000-feet of wire. For larger installations, move the switch to large (LG).

2. Adjust pet fencing field – Move the FIELD WIDTH knob to the 9 o'clock position.

3. Test system

– Select a section of straight boundary wire that is at least 50 feet long. Hold the supplied test light across the collar's skin contacts, and position the collar at your dog's neck height. Slowly walk the collar toward the boundary wire. Listen for the warning tone and watch for the test light to illuminate. The wider you can make the pet fencing field, the less chance your dog can run-through. Adjust the FIELD WIDTH as necessary and test again.

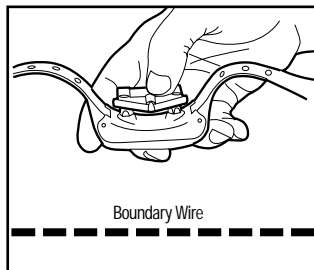

Test in a number of different areas until you are satisfied that the system is functioning properly.

Next, walk all around the "safe" part of the yard to ensure there are no areas where the signal may be lost, particularly where there may be buried wires or cables. Test the collar in and around the inside of the house as well.

As mentioned, cable and wires from cable TV, electrical or telephone lines may conduct pet fencing signals inside and outside the house that can activate the dog's collar accidentally. While rare, if this occurs your boundary wire is probably too close to these outside lines and should be moved or modified; see previous section about running pet fencing wires perpendicular to utility lines.

Step 7 Bury Fence Wire

You may need the following tools for efficient installation: Straightedge spade or a gas-powered edger. If you plan on running the wire across a driveway you may also need a caulk gun, silicone caulking and a circular saw with a masonry blade.

1. Ensure system is turned off – Turn off the transmitter and unplug the adapter from the AC outlet.

2. Bury the wire – With a straightedge spade, dig a slot 1 to 3-inches deep in your turf. Rock the spade back and forth to create a V-shaped slot. You may choose to use a gas-powered edger as well. A 30 to 45-degree angle cut will be the easiest to close and keep the wire in the slot. Make sure there is a little slack in the wire as you bury it to compensate for expansion and contraction due to temperature changes.

When crossing an asphalt driveway, make a 3/8-inch perpendicular cut across the driveway using the circular saw and masonry blade. Place the wire in the crack and seal with asphalt sealant. With concrete driveways, there is usually an expansion joint that can be cleaned out and used for the same purpose and covered with clear silicone caulk.

The wire can be placed underwater in creeks and streams by running the wire through PVC pipe or a length of cut garden hose to prevent the wire from being damaged.

3. Place training flags – Repeat the TEST YOUR FENCE steps outlined in the Step 6. As soon as you hear the warning tone, place one flag. Repeat the process in 10-foot intervals around the pet fencing area. The flags will be your dog's visual clue to the boundary during training, and will

be gradually removed during the training process. You are now ready to begin training your dog. See the Training and Troubleshooting guide.

Working With INNOTEK® ZONES™ IUC-5200 users

This collar is also compatible with INNOTEK® ZONES™, a battery-powered portable indoor avoidance system. Place a ZONES™ transmitter near anything you want your pet to avoid: plants, trash cans, fine furniture. When your dog wearing the collar enters the avoidance ZONE, he will receive a mild correction, designed to create just enough discomfort to get him to leave the area.

Setting your ZONE

Install three AA alkaline batteries (not included) in the ZONE. Determine the desired location and size for your pet-free zone. Hold the ZONE so that the name is right side up. Press the arrow-shaped UP button. A segmented line will appear in the window. Each segment represents approximately two feet of range from the unit. The arrow-shaped DOWN button reduces the diameter of the pet-free zone. Once range is set, place ZONE in desired area. Zones has a maximum range of 5-6 feet.

Testing the Zone

You may wish to verify the range of the pet-free zone. Holding the collar, start outside the range and walk slowly toward the ZONE. The collar will emit a high-pitched tone as it approaches the outer range of the pet-free zone, followed by an escalating level of correction. If you cannot hear the tone, hold the supplied test light on the collar probes and repeat this test. The light will illuminate, demonstrating stimulation.

Your First Indoor ZONES Session

Move your dog to an area away from the pet-free zone. Be sure he's wearing his INNOTEK® collar. Allow your dog to enter the zone on his own. Monitor your dog during his first session. Dogs learn at different speeds. It may take several times for your dog to honor the pet-free zone. You may also need to adjust the range so that your dog receives the warning sooner. If you find that your dog is confused or unsure how to avoid the correction, it may be useful to put a long leash on your dog and show him how to avoid the ZONE by gently guiding him out of the range once he has entered. Be sure to praise your dog for leaving the pet-free zone.

Important Information About Range

Your ZONES™ transmitter communicates with your pet's collar via a radio frequency signal. Due to the inherent properties of radio signals, some locations may affect the maximum range that can be achieved. This may be particularly noticeable around metal objects. Should you find that

you are not getting the desired range at the maximum setting, altering the ZONE location by a few feet or changing how the Zone is positioned (ie: standing on end instead of laying flat) may help cover your pet free area.

Turning the Units OFF

To turn the ZONE OFF, continue to press and release the DOWN arrow button until no bars are present in the window. The ZONE is now OFF.

Multiple Dog Households

All zones and collars come preset in mode A. In multiple dog households, it may be desired to allow one dog access to an area while denying access to another. Each collar can operate on one of two different modes - A or B.

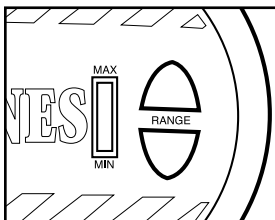

Each Zone may also be set to either A, B, or both (A and B) to allow multiple configurations.

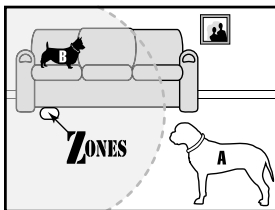

When set to mode A, the ZONE denies access to dogs wearing a collar programmed to mode A.

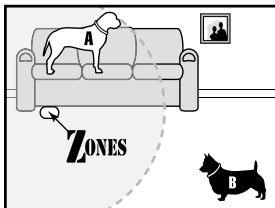

When set to mode B, the ZONE denies access to dogs wearing a collar programmed to mode B.

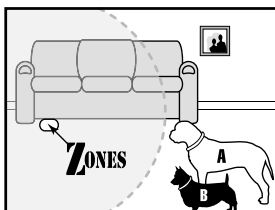

When set to modes A & B, the ZONE denies access to any and all dogs wearing ZONES collars.

Changing the system mode setting

1. Take your collar with a full battery charge (green light) and set it within one foot of the Zone.
2. With the Zone turned OFF, press and hold the DOWN arrow button until a vertical bar appears in the window. This bar will indicate whether the Zone is set to mode A or mode B. The collar will be programmed to reflect the mode setting on

your transmitter. Continue to hold DOWN arrow button through the end of the next step. NOTE: You cannot reprogram the collar if the Zone is set on A/B mode.

3. Press and release the UP arrow button until desired mode is indicated. Now press and hold the UP arrow button until one bar segment appears, followed by three beeps from the collar. The collar is now set for your chosen mode.

4. **Important:** Any collar that is within 6 feet of the transmitter and turned on will be reprogrammed by these steps. You may use this feature to program multiple collars at once. However, make sure any collar you do not wish to reset is 6 feet beyond the transmitter during this procedure.

Do not perform set-up procedure while the collar is on your dog.

Trouble Shooting	
Transmitter does not appear to work	Check / charge batteries in collar
	Check segment indicator on transmitter
	Check / replace batteries in transmitter
	Use an Innotek test light to check collar for stimulation
	Increase Zone size on transmitter
	Check collar fit and make sure contacts are touching skin
Range is too low	Check that transmitter Zone is set to reflect collar setting (A/B/AB) - refer to Multiple Dog Household section for instructions
	Check / charge batteries in collar
Range is too high	Adjust transmitter to increase Zone size
	Adjust transmitter to decrease Zone size
Dog seems to receive no stimulation	Check / charge batteries in collar
	Use a test light to check for stimulation
Collar fails to sound off warning tone	Check the Zone setting on transmitter
	Check / charge batteries in collar
	Dogs easily hear warning tone, but it may be a pitch that is difficult for you to hear
	Use an Innotek test light to check collar for stimulation
	Use an Innotek test light to check collar for stimulation

Add ZONES to your home

If you find your ZONE an effective way to keep your dog from problem areas in your home, additional Zones are available where you bought your IUC-5200 system, or call us at 1-800-826-5527.

ALL USERS

Even if you did not purchase the IUC-5200 Contain 'N' Zones system, your dog's collar will work with the Zones system. Zones products are available where you bought your in-ground fencing system, or call us at 1-800-826-5527.

Contain 'N' Train® IUC-5100 Users Only

Your Contain 'N' Train® system includes a handheld remote. The remote offers 9 levels of preset stimulation. Level 1 delivers the mildest level, and Level 9 the most intense. The collar will stimulate for as long as you hold down the center red stimulation button (maximum 10 seconds).

You can use your remote to train your dog within the boundaries of your in-ground fence, or you may remove the dog from the fenced area. Be sure to remove the collar from the dog when crossing the field boundaries. The training system has a working range of up to 150 yards.

Contain 'N' Train Collar

Your collar features two LED lights. The one on the left reflects the status of your system's in-ground fence. The light on the right reflects commands from the hand-held remote.

Remote controls

The miniature handheld remote includes a built-in antenna, LCD display, and 6 control buttons.

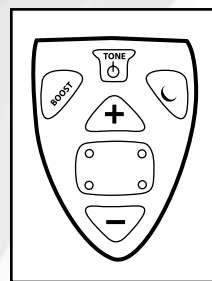

- **Stimulation** – The red, center button. Sends stimulation signal to the collar at the intensity shown in the display window. The button features four raised bumps, one at each corner, for user confidence when operating by touch only.

- **Level up (+) / Level Down (-)** – arrow shaped buttons adjust stimulation intensity through a range of levels from Low-1 to High-9.



- **Tone** – Green, speaker-shaped button. Produces a harmless tone at the collar. No stimulation is delivered. Use tones to reinforce correction. Some people use tone as an alternate form of correction. Button is also used as ON/OFF (see below).

- **Dog 1 / Dog 2** – Switches remote controls from the Dog 1 collar to the Dog 2 collar; great when training two dogs at once. You can purchase a second accessory collar to expand your system to train two dogs.

- **BOOST** – Red, smaller stimulation button. Sends a stimulation signal 2 levels higher than that shown in the display window. For example, if you are training your dog at level 3, pressing BOOST delivers a stimulation at level 5.

The display shows stimulation levels 1 through 9. The lower part of the display shows which collar is active. Press "Dog1/Dog 2" button once or twice until collar 1 shows as active.



The display will stay ON, only going OFF 30 minutes after the last button press

The back of the remote features a recessed groove in which to rest your index finger while operating the controls with your thumb. For best results at distance, take care not to cover or shield the antenna with your body or hand, or you may see a reduction in transmission range.

The remote is water-proof, though submersion is not recommended. It operates on a replaceable 12v Alkaline battery (23A or A23). These are commonly available where you bought your system or where batteries are sold.

ON/OFF

To turn the training mode of the collar on or off, hold the collar within 1 inch of the remote antenna, taking care not to touch the skin contact points. Press "Dog1/Dog 2" button once or twice until collar 1 shows as active. Press the TONE button, also labeled "1/0". The collar will emit a start-up tone, and the right-hand light will glow solid green. This ON/OFF command only works when remote and collar are in close proximity; it will not work at a distance. Never turn the unit ON/OFF while your dog is wearing the collar.



When not in use, be sure training function is OFF (right hand collar light is off), or you may drain battery.



About Stimulation

We recommend that you always start training your dog with the lowest stimulation, and increase to a higher level if necessary. You will know when you've reached the right level when your dog responds by twitching his head, neck or shoulders or by perking up his ears. If the dog vocalizes, you may need to go to a lower level.

Control the level of stimulation with the UP (+)/DOWN (-) arrow buttons. Adjust the stimulation level from a low of 1, to a high of 9. To correct your dog, press the center red stimulation button.

You control the length of the stimulation by the time you press the button. For a short stimulation, press and release the button. For a longer stimulation, hold the button down. A maximum of 10 seconds may be applied before the safety feature to prevent over-correction engages. After 10 seconds, stimulation will be locked out for another 10 seconds.

BOOST

Pressing the  button sends a continuous signal to the collar, raising the stimulation by 2 levels. For example, if the stimulation level is set at Level 3, a touch of the  control will correct at Level 5. Some trainers like instant access to a higher setting for circumstances with high distractions.

Tone

The  button sounds a tone in the collar. No stimulation is delivered when this button is pressed. The tone continues for as long as the button is held down. There is no stimulation delivered by the collar when pressing the tone button. Tones can help strengthen a dog's response to training. Tones can be used as a warning tone prior to pressing the stimulation button; or can be a reward tone when presented with a praise, play, or food for good behavior.

The use of training tone is optional. Its use varies between popular training methods. Whether the tone will mean reward or warning to your dog is up to the training method you choose. Remember: the one training tone CANNOT be both a warning and a reward.

To learn more about tone training, consult your veterinarian or a qualified canine training professional.

Compliance with US FCC and European Telecommunications Regulations

This INNOTEK® Remote Training System is designed to meet worldwide requirements for telecommunications compliance. This system contains both receiver and transmitter devices. In the US, each transmitter device complies with Part 95 and/or Part 15 of the FCC rules; each receiver device complies with Part 15 of the FCC rules.

Each device complies with Part 15 of the FCC Rules. Operation is subject to the following two conditions: (1) this device may not cause harmful interference, and (2) this device must accept any interference received, including interference that may cause undesired operation. Each device may display indications as to where this system is compliant worldwide. Note that in some countries, the use of this INNOTEK® Remote Training System may be limited due to national frequency planning requirements, and the user is always responsible for respecting national and local rules before operating.

U.S. Patent No. 6,184,790; 6,459,378; 6,327,999, 6,807,720; D417,835. Other patents pending.

FREE Professional Training Support

Additional behavior or training issues? Looking for the best way to get a well-behaved dog? Just call our **FREE** Professional Training Support hotline at

1-800-364-3362

We care. Call us first.

LIMITED LIFETIME WARRANTY

Invisible Technologies™, Inc., warrants to the original retail purchaser, that INNOTEK® brand products will be free from defects in material and workmanship, under normal use, for a period of one year from the date of the original retail purchase. This Limited Warranty excludes: accidental damage due to dog chews; lightning damage where an INNOTEK® lightning protection component is not in use (in-ground pet fencing systems); or neglect, alteration and misuse.

Invisible Technologies™ offers several product exchange options during the warranty period. If service is required, call 1-800-826-5527 to discuss the service plan that best serves your needs. Costs are dependent on the processing time and the desired shipping options. Please do not return this product to your retailer.

After one year from date of original retail purchase, we will repair, replace or upgrade your product at a fixed rate based on the component.

Invisible Technologies™, Inc., shall not be liable or responsible for any incidental or consequential damages resulting from the use of the product or caused by any defect, failure or malfunction of the product, whether a claim is based upon warranty, contract, negligence or otherwise.

INNOTEK, and the INNOTEK logo are registered trademarks of Invisible Technologies, Inc. UltraSmart and the UltraSmart logo, Contain 'N' Train, ZONES and Instant Pet-Proofing Barriers are trademarks of Invisible Technologies, Inc. All other product and service names are the property of their respective owners. Patents pending.

© 2004, Invisible Technologies, Inc. All rights reserved

Training Notes:



Invisible Technologies, Inc.
1-800-826-5527
www.innotek.net