

PetSafe® Bark Control Collar™ Operating Guide

Please read this entire guide before beginning

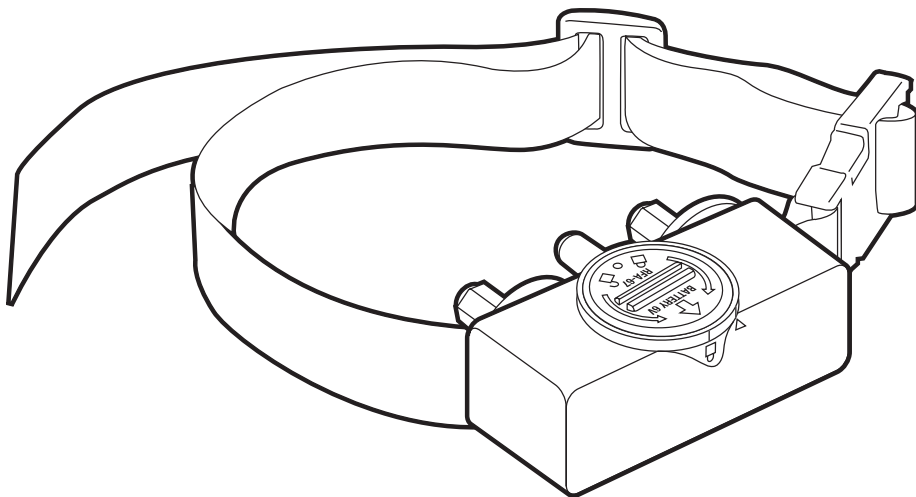

Thank you for choosing PetSafe®, the #1 selling brand of electronic training solutions in the world. Our mission is to ensure your pet’s safety by providing you the tools and techniques to successfully train your pet. If you have any questions, please contact the Customer Care Center at 1-800-732-2677 or visit our website at www.petsafe.net.

Table of Contents

Components	3
Features	3
How the PetSafe Bark Control Collar™ Works.....	4
Key Definitions	4
Fit the Bark Control Collar.....	5
To Insert and Remove the Battery.....	7
What to Expect During Use of the Bark Control Collar	8
Regular Maintenance	8
To Test the Bark Control Collar	9
Accessories	9
Frequently Asked Questions	10
Troubleshooting.....	11
To Discharge the Bark Control Collar	11
Terms of Use and Limitation of Liability.....	12

“In a Tuskegee University study of adult shelter dogs wearing the PetSafe Bark Control Collar™ for six 30-minute sessions over two weeks, we detected no long-term adverse effects, and all dogs dramatically reduced their barking by the second day.”

Dr. Janet Steiss and Dr. Caroline B. Schaffer
Tuskegee University

Components

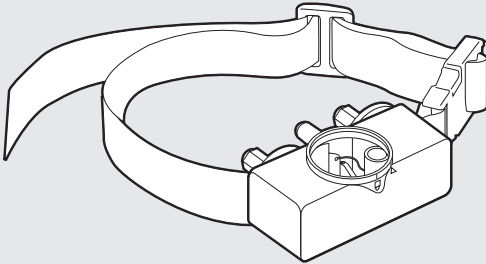

PetSafe Bark Control Collar™



Battery
(PetSafe® RFA-67)



Operating Guide



Warranty Card



Bark Control Video CD

Features

- 6 levels of Static Correction, automatically adjusts to your dog's temperament starting at the lowest level
- Low Battery Warning Indicator
- Waterproof
- Lifetime Limited Warranty

How the PetSafe Bark Control Collar™ Works

The PetSafe Bark Control Collar™ effectively and humanely stops barking when it is worn. When the vibration of your dog's bark triggers the Sensor Probe, a Static Correction is administered through the Contact Points. The Bark Control Collar starts with the lowest level of Static Correction and then increases through 6 levels each time your dog barks within 30 seconds of the previous bark. If your dog does not bark again within 30 seconds, the Bark Control Collar will reset itself to the lowest level of Static Correction. Along with each Static Correction, there will be an audible beep. As an added safety feature, the Bark Control Collar will automatically shut off for 3 minutes if your dog barks 15 times or more within a 50-second period.

Important:

- **DO NOT use the Bark Control Collar with any additional collars, tags, leashes or other items that may cause vibration and trigger a false correction.**
- **Your dog may wear a harness for attaching a leash and/or tags while using the Bark Control Collar.**
- **Before playing with your dog, remove the Bark Control Collar. The activity may cause your dog to bark, which could lead to him associating the play with the Static Correction.**
- **Never leave the Bark Control Collar on for more than 12 consecutive hours.**

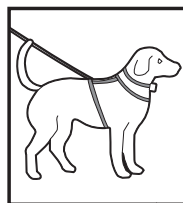
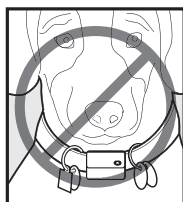

Key Definitions

Contact Points: Deliver the safe Static Correction.

Sensor Probe: Detects the vibrations of your dog's barking. *Note: The Sensor Probe is not adjustable.*

Low Battery Indicator: The Indicator light will begin flashing when battery is low.

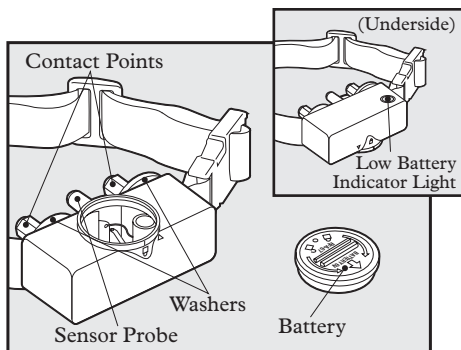

Fit the Bark Control Collar

Important: The proper fit and placement of your Bark Control Collar is important for effective operation. The Contact Points must have direct contact with your dog's skin on the underside of his neck.

To assure a proper fit, please follow these steps:

1. Make sure that the battery is not installed in the Bark Control Collar.
2. Start with your dog standing comfortably.
3. Place the Bark Control Collar high on your dog's neck close to the ears. Center the Contact Points underneath your dog's neck, touching the skin.

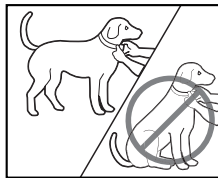

Note: It is sometimes necessary to trim the hair around the Contact Points to make sure that contact is consistent.

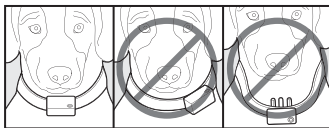

4. Check the tightness of the Bark Control Collar by inserting one finger between the end of a Contact Point and your dog's neck. The fit should be snug but not constricting.
5. Allow your dog to wear the Bark Control Collar for several minutes then recheck the fit. Check the fit again as your dog becomes more comfortable with the Bark Control Collar.



6. Trim the collar as follows:
 - a. Mark the desired length of the Bark Control Collar with a pen. Allow for growth if your dog is young or grows a thick winter coat.
 - b. Remove the Bark Control Collar from your dog and cut off the excess.
 - c. Before placing the Bark Control Collar back onto your dog, seal the edge of the cut collar by applying a flame along the frayed edge.

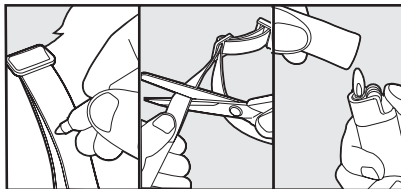

Important: For comfort, safety and effectiveness of product, please ensure the following:

- Check the fit to prevent excessive pressure by being able to insert one finger between the Contact Point and your pet's skin.
- Your dog must be carefully examined daily for any signs of a rash or sore.
- If a rash or sore is observed, discontinue the use of the Bark Control Collar for a few days.
- If the condition persists beyond 48 hours, see your veterinarian.
- Your pet's neck and the Contact Points must be washed weekly with a wash cloth and mild hand soap, then rinsed thoroughly.

A condition called Pressure Necrosis, which is a devitalization of the skin due to excessive and prolonged contact against the Contact Points, may occur if the steps above are not followed.

To Re-Thread the Collar

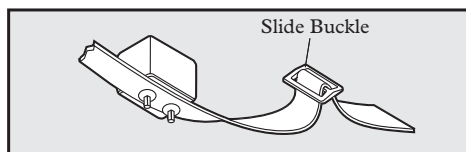

The slide buckle prevents the collar from becoming loose around your pet's neck.

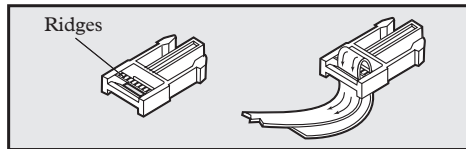

The ridges must be facing up; the collar will slip if it is not properly threaded.

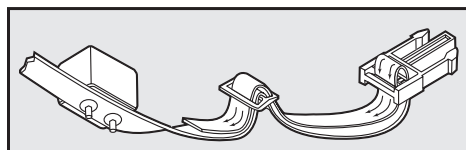

To Insert and Remove the Battery

Note: Do not install the battery while the Bark Control Collar is on your dog.

This Bark Control Collar utilizes a replaceable PetSafe® battery (RFA-67). This unique battery is designed to make battery replacement easier and increase water protection.

To insert the battery, align the symbols on the battery (arrow) and Bark Control Collar (triangle). Use a large coin to turn the battery clockwise until the arrow lines up with the lock symbol on the housing.

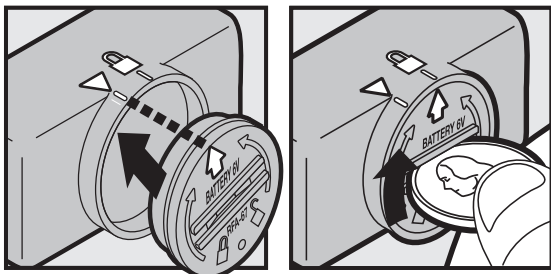

To remove the battery, turn the battery counter-clockwise using a large coin. **DO NOT** attempt to cut into or pry open the battery. Be sure to discard the used battery properly.

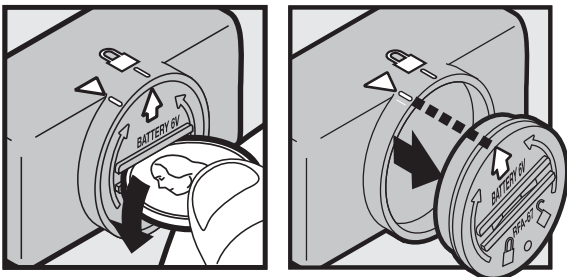

A replacement PetSafe® battery (RFA-67) can be found at many retailers. Contact the Customer Care Center at 1-800-732-2677 or visit our web site at www.petsafe.net to locate a retailer near you.

Battery Life

Average battery life is 3 to 6 months, depending on how often your dog barks. However, due to greater use during your dog's training, your first battery may not last as long as replacement batteries.

Low Battery Indicator

During normal operation the Indicator Light remains off. As the product is used, the battery will be drained to a weakened state. At this point, the Indicator Light will begin to flash to show that it is time to change the battery.

What to Expect During Use of the Bark Control Collar

Important: Do not leave your dog alone the first few times he receives a Static Correction.

Place the Bark Control Collar properly on your dog and wait nearby until he barks. Most dogs will understand very quickly that the Bark Control Collar is disrupting their urge to bark and will relax and stop barking. Because the Static Correction from the Bark Control Collar may be surprising or startling at first, some dogs may bark more at the initial correction.

On rare occasions, a dog may get into a bark-correction-bark-correction cycle. If this happens, reassure your dog with calm, soothing tones. As your dog relaxes, he will understand that if he becomes quiet, he will not receive any more Static Corrections. The small minority of dogs that have this reaction will only have it the first time they wear the Bark Control Collar.

You should notice a reduction in your dog's barking within the first couple of days that he wears the Bark Control Collar. At this point, it is important to remember the learning process is still not complete. Dogs will "test" this new learning experience and will increase their attempts to bark. This usually occurs during the second week a dog wears the Bark Control Collar. If this does occur, remain consistent and do not alter your use of the Bark Control Collar. You must place the Bark Control Collar on your dog in every situation when you expect him to be quiet. If your dog is not wearing the Bark Control Collar, he may resume barking and his learning would suffer a setback.

Regular Maintenance

- Check Contact Points for tightness weekly
Note: Do not adjust the factory preset Sensor Probe.
- Clean Contact Points with alcohol weekly
Note: Remove the battery and discharge the Bark Control Collar before touching the Contact Points.
- Check your dog's neck for irritation and wash neck weekly.

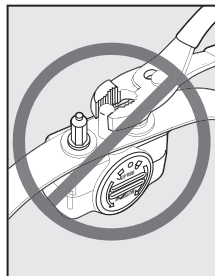

To Test the Bark Control Collar

Slide the Sensor Probe across a rough surface for at least 10 inches. The Bark Control Collar should beep. If your Bark Control Collar doesn't beep during this test, see "The Bark Control Collar does not beep" in the "Troubleshooting" section, and continue with the second step.

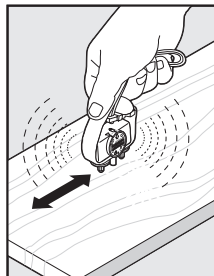

Accessories

To purchase additional accessories for your PetSafe Bark Control Collar™, contact the Customer Care Center at 1-800-732-2677 or visit our website at www.petsafe.net to locate a retailer near you.

Component	Part Number
Battery - two pack	RFA-67D-11
Replacement Collar	RFA-68
Accessory Pack (Extra Contact Points, washers, and battery)	RFA-118
Bark Control Video - VHS	RFA-149

Frequently Asked Questions

Will my dog stop barking completely?	<ul style="list-style-type: none">• The Bark Control Collar effectively and humanely stops all barking when it is worn. It should only be worn during periods of unwanted barking.
My dog has a sensitive nature. Can I lower the Static Correction level?	<ul style="list-style-type: none">• You can obtain a resistor to reduce the Static Correction level by contacting the Customer Care Center at 1-800-732-2677.
Will another dog's bark set off the Bark Control Collar?	<ul style="list-style-type: none">• No.
Is the Bark Control Collar safe and humane?	<ul style="list-style-type: none">• Yes. The Bark Control Collar is designed to get your dog's attention, not to punish him. However, the initial Static Correction may startle your dog.
Will the Bark Control Collar work for my dog?	<ul style="list-style-type: none">• The Bark Control Collar is safe and effective for all breeds and sizes of dogs, though it may be too large for dogs under 8 pounds to wear comfortably.

Troubleshooting

The Bark Control Collar does not beep.	<ul style="list-style-type: none">• Test the Bark Control Collar (see “To Test the Bark Control Collar” section).• If your Bark Control Collar does not beep during this test, try the same test on a rougher surface.• Ensure that the battery is properly installed.• Replace the battery.• If the Bark Control Collar still does not beep, contact the Customer Care Center at 1-800-732-2677.
My Bark Control Collar beeps, but my dog keeps barking (does not respond to the Static Correction).	<ul style="list-style-type: none">• Tighten the Bark Control Collar and/or trim your dog’s hair where the Contact Points touch his neck to ensure good skin contact.• Replace the battery.• If your dog still does not respond, contact the Customer Care Center at 1-800-732-2677.
The Bark Control Collar Indicator Light is flashing.	<ul style="list-style-type: none">• Replace the battery

To Discharge the Bark Control Collar

Important: Avoid touching the Contact Points and Sensor Probe unless the Bark Control Collar is completely discharged.

After battery removal, the Bark Control Collar retains some stored energy and may activate 2 or 3 additional times. To completely discharge the Bark Control Collar, slide the Sensor Probe across a table or hard surface several times, until the Bark Control Collar stops beeping.

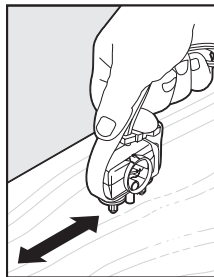

Terms of Use and Limitation of Liability

1. Terms of Use

This Product is offered to you conditioned upon your acceptance without modification of the terms, conditions and notices contained herein. Usage of this Product implies acceptance of all such terms, conditions, and notices.

2. Proper Use

This Product is designed for use with pets where training is desired. The specific temperament of your pet may not work with this Product. We recommend that you not use this Product if your pet is less than 8 pounds or if your pet is aggressive. If you are unsure whether this is appropriate for your pet please consult your veterinarian or certified trainer.

Proper use includes reviewing the entire Guide provided with your Product and any specific Caution statements.

3. No Unlawful or Prohibited Use

This Product is designed for use with pets only. This pet training device is not intended to harm, injure or provoke. Using this Product in a way that is not intended could result in violation of Federal, State or local laws.

4. Limitation of Liability

In no event shall Radio Systems Corporation be liable for any direct, indirect, punitive, incidental, special or consequential damages, or any damages whatsoever arising out of or connected with the use or misuse of this Product. Buyer assumes all risks and liability from the use of this Product.

5. Modification of Terms and Conditions

Radio Systems Corporation reserves the right to change the terms, conditions and notices under which this Product is offered.

Radio Systems Corporation
10427 Electric Avenue
Knoxville, TN 37932
1-800-732-2677
www.petsafe.net
400-665/1